

Data Sheet



Article number: 2314451403

Description: E+G Cast iron wheel 451403
RE.F4-150-RBL - loose wheel

Measures

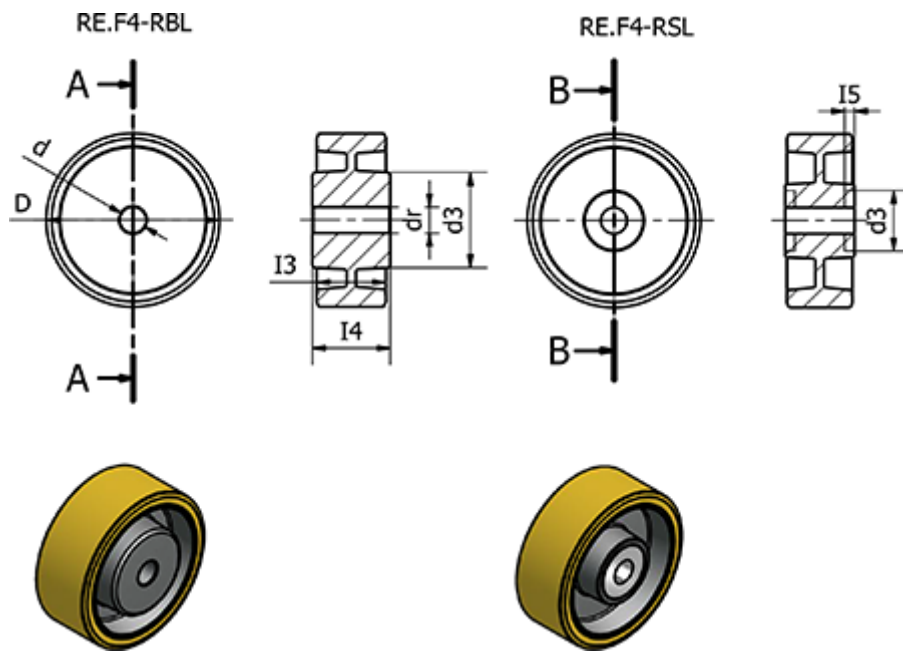

Code	= 451403	Max static load (N)	= 9100
d	= 150	Rolling resistance (N)	= -
d3	= 70	Type	= RE.F4-150-RBL
dr	= 40	Weight (g)	= 3700
Dynamic carrying capacity (N)	= 7000		
I3	= 50		
I4	= 60		
I5	= -		